

YOUSE

Sweden & Martina Group

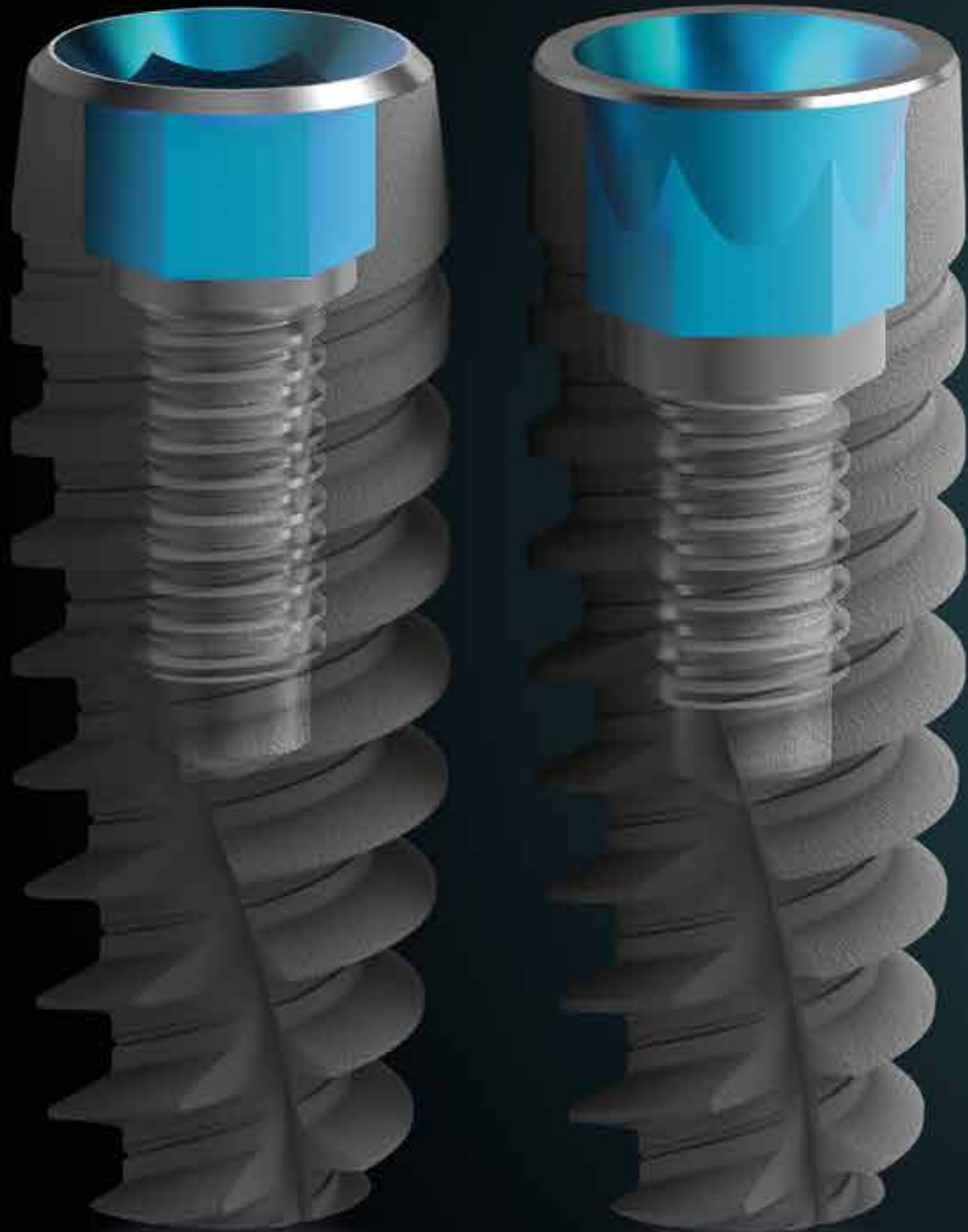

Compatibility for **You.**

YOUSE IMPLANTS

The Youse line was created to simplify the daily practice of the dentist, enabling him to deal with any clinical situation. Youse implants are available in two different morphologies, one with a truncated conical profile and one with a more markedly conical geometry, each of which is available with either a conical connection (YOUSE-V) or an internal hex connection (YOUSE-I).

Truncated conical morphology and narrow thread

The thread has a 0.6 mm pitch with a double lead, which allows progressive and controlled insertion even in particularly compact bone. Insertion is facilitated thanks to the tapered apex and vertical incisions that give the implant great self-tapping capacity.

Conical morphology and wide thread conical connection

The thread has a pitch of 1.1 mm with double lead and increasing loop depth in the coronal-apical direction. The Youse wide thread implant is particularly effective in the execution of post-extraction protocols and in cases where maximum primary stability is required even in poor quality bone.



Internal hexagon connection I 

Conical connection V 

 Internal hexagon connection I

 Conical connection V

The apex of both Youse implant morphologies is characterised by a rounded profile, ideal for sinus lift procedures.

DUAL PRINCIPLE THREAD

One-principle thread

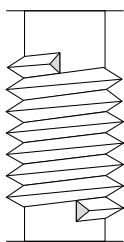

Dual principle thread (Youse implants)

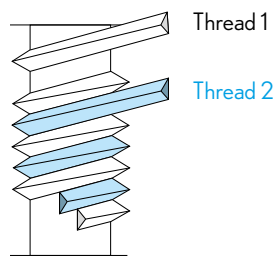

The dual principle in the thread of the Youse implants has the great advantage of optimising the insertion phase into the bone and maximising its efficiency.



SURFACE TREATMENT

The literature has widely demonstrated the correlation between a highly rough implant surface and a correct and rapid osseointegrative process.

The Yousurface, thanks to sandblasting treatment and a subsequent etching process achieves an ideal level of roughness to promote osteoblastic activity and encourage rapid and effective healing.

After thorough decontamination, which cleans the fixtures of processing residues, the last step in their production process is the sterilisation of the fixtures, which is done by beta irradiation.



The color code of the implant diameter is indicated in the implant holder. The surgical cover screw is located housed in the vial cap.

ø 3.30



ø 3.75



ø 4.20



ø 5.00



Internal hexagon connection I

The **I-connection** has an **internal hexagon** of 2.4 mm, which is unique for all implant diameters.

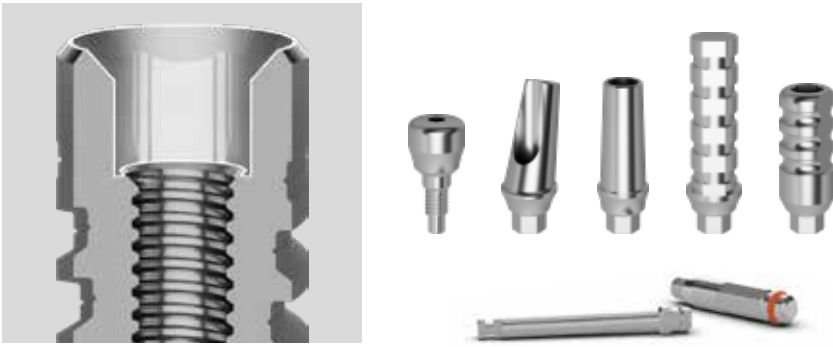

Conical connection V

The **V-connection** features a **conical** implant-post coupling system with an apical hexagon for repositioning.

Narrow profile (N)

In the two narrowest implant diameters in the Youse range, the 3.30 and 3.75, the V tapered connection has a **narrow platform (N)**, with a connection diameter of 3.00 mm, ideal for managing reduced interproximal spaces in the front sectors.

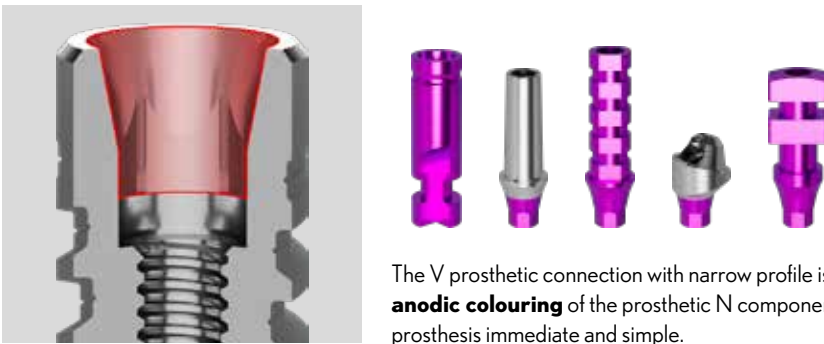

The V prosthetic connection with narrow profile is easily identifiable thanks to the **magenta anodic colouring** of the prosthetic N components, which makes management of the prosthesis immediate and simple.

Regular profile (R)

The V connection of diameters 4.20 and 5.00 is characterised by a **profile** called **regular (R)**, with a connection diameter of 3.40 mm, which gives strength and robustness to the prosthesis, as required for use typically in **distal sectors** and **subject to significant masticatory loads** typical of the use of these implant diameters.

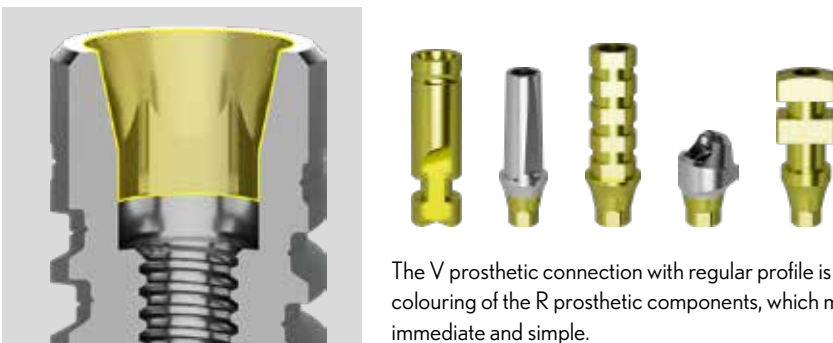

The V prosthetic connection with regular profile is easily identifiable thanks to the yellow anodic colouring of the R prosthetic components, which makes handling the prosthesis much more immediate and simple.

Note: the **drivers** are marked with a reference coloured **red** for the narrow profile and **yellow** for the regular profile, positioned at the base of the ratchet attachment and around the shank of the contra-angle attachment.



Driver narrow profile (N)

























Driver regular profile (R)

IMPLANTS RANGE























YOUSE-V Truncated conical morphology with narrow thread, conical connection



Platform	Narrow ▼	Narrow ▼	Regular ▼	Regular ▼
ø body	ø 3.30 ●	ø 3.75 ●	ø 4.20 ●	ø 5.00 ●
h 7.00	-	-	 YV-42-07	 YV-50-07
h 8.50	 YV-33-08	 YV-37-08	 YV-42-08	 YV-50-08
h 10.00	 YV-33-10	 YV-37-10	 YV-42-10	 YV-50-10
h 11.50	 YV-33-11	 YV-37-11	 YV-42-11	 YV-50-11
h 13.00	 YV-33-13	 YV-37-13	 YV-42-13	 YV-50-13
h 15.00	-	 YV-37-15	 YV-42-15	-
h 18.00	-	 YV-37-18	-	-
Surgical cover screw				
	 YV-N-VCC	 YV-R-VCC		

YOUSE-VL Wide thread conical morphology, conical connection



Platform	Narrow ▼	Narrow ▼	Regular ▼	Regular ▼
ø body	ø 3.30 ●	ø 3.75 ●	ø 4.20 ●	ø 5.00 ●
h 7.00	-	-	 YVL-42-07	 YVL-50-07
h 8.50	 YVL-33-08	 YVL-37-08	 YVL-42-08	 YVL-50-08
h 10.00	 YVL-33-10	 YVL-37-10	 YVL-42-10	 YVL-50-10
h 11.50	 YVL-33-11	 YVL-37-11	 YVL-42-11	 YVL-50-11
h 13.00	 YVL-33-13	 YVL-37-13	 YVL-42-13	 YVL-50-13
h 15.00	-	 YVL-37-15	 YVL-42-15	-
h 18.00	-	 YVL-37-18	-	-

Surgical cover screw



YV-N-VCC





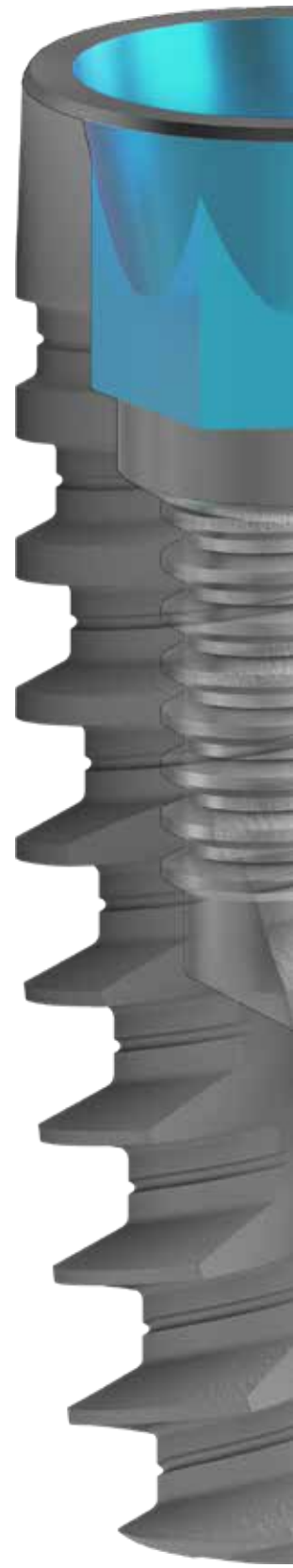



















YV-R-VCC





YOUSE-I Truncated conical morphology with narrow thread, internal hexagonal connection

Unique platform

\varnothing body	\varnothing 3.30 	\varnothing 3.75 	\varnothing 4.20 	\varnothing 5.00 
h 7.00	-	 YI-37-07	 YI-42-07	 YI-50-07
h 8.50	-	 YI-37-08	 YI-42-08	 YI-50-08
h 10.00	-	 YI-37-10	 YI-42-10	 YI-50-10
h 11.50	-	 YI-37-11	 YI-42-11	 YI-50-11
h 13.00	-	 YI-37-13	 YI-42-13	 YI-50-13
h 15.00	-	 YI-37-15	 YI-42-15	-
h 18.00	-	 YI-37-18	-	-

Surgical cover screw

























YI-VCC

YOUSE-IL Truncated conical morphology with narrow thread, internal hexagonal connection



Unique platform

\varnothing body	\varnothing 3.30 	\varnothing 3.75 	\varnothing 4.20 	\varnothing 5.00 
h 7.00	-	 YIL-37-07	 YIL-42-07	 YIL-50-07
h 8.50	-	 YIL-37-08	 YIL-42-08	 YIL-50-08
h 10.00	-	 YIL-37-10	 YIL-42-10	 YIL-50-10
h 11.50	-	 YIL-37-11	 YIL-42-11	 YIL-50-11
h 13.00	-	 YIL-37-13	 YIL-42-13	 YIL-50-13
h 15.00	-	 YIL-37-15	 YIL-42-15	-
h 18.00	-	 YIL-37-18	-	-

Surgical cover screw



YI-VCC

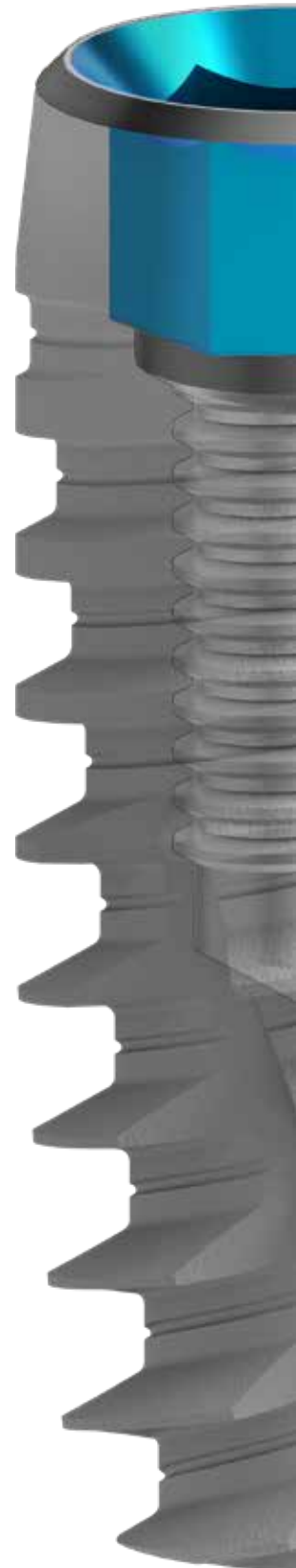

SURGICAL KIT

The Youse surgical kit is designed to offer the possibility of inserting all implants in the range, in both morphologies and in both prosthetic connections.

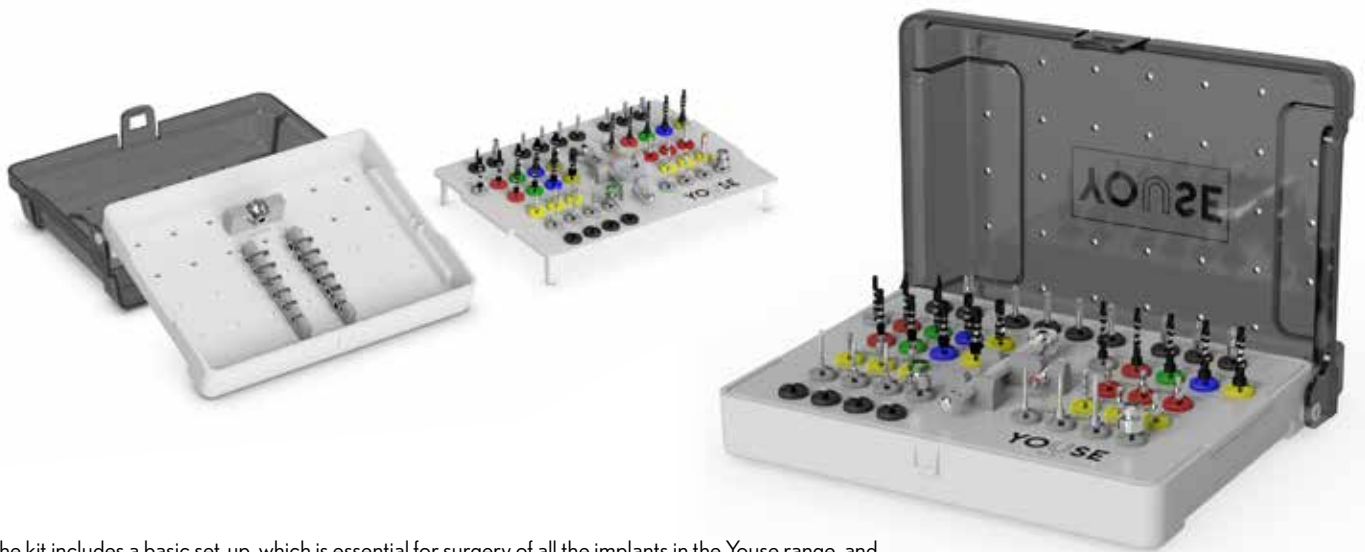

The kit includes a basic set-up, which is essential for surgery of all the implants in the Youse range, and four optional set-ups, which can be combined depending on the type of implant chosen. The clear and intuitive layout of the kit makes the management of the different configurations extremely simple.

You can purchase the empty tray with the code Y-TRAY.

Basic set-up (code Y-KIT)

The surgical kit is delivered complete with the basic set-up, which includes the tray and standard instruments that are needed for the surgery of all Youse implants, regardless of chosen morphology and prosthetic connection.

The supplementary set of S-stops is also available for individual sale under the code Y-ST-S-SET.

The supplementary set of L-stops is also available for individual sale under the code Y-ST-L-SET.

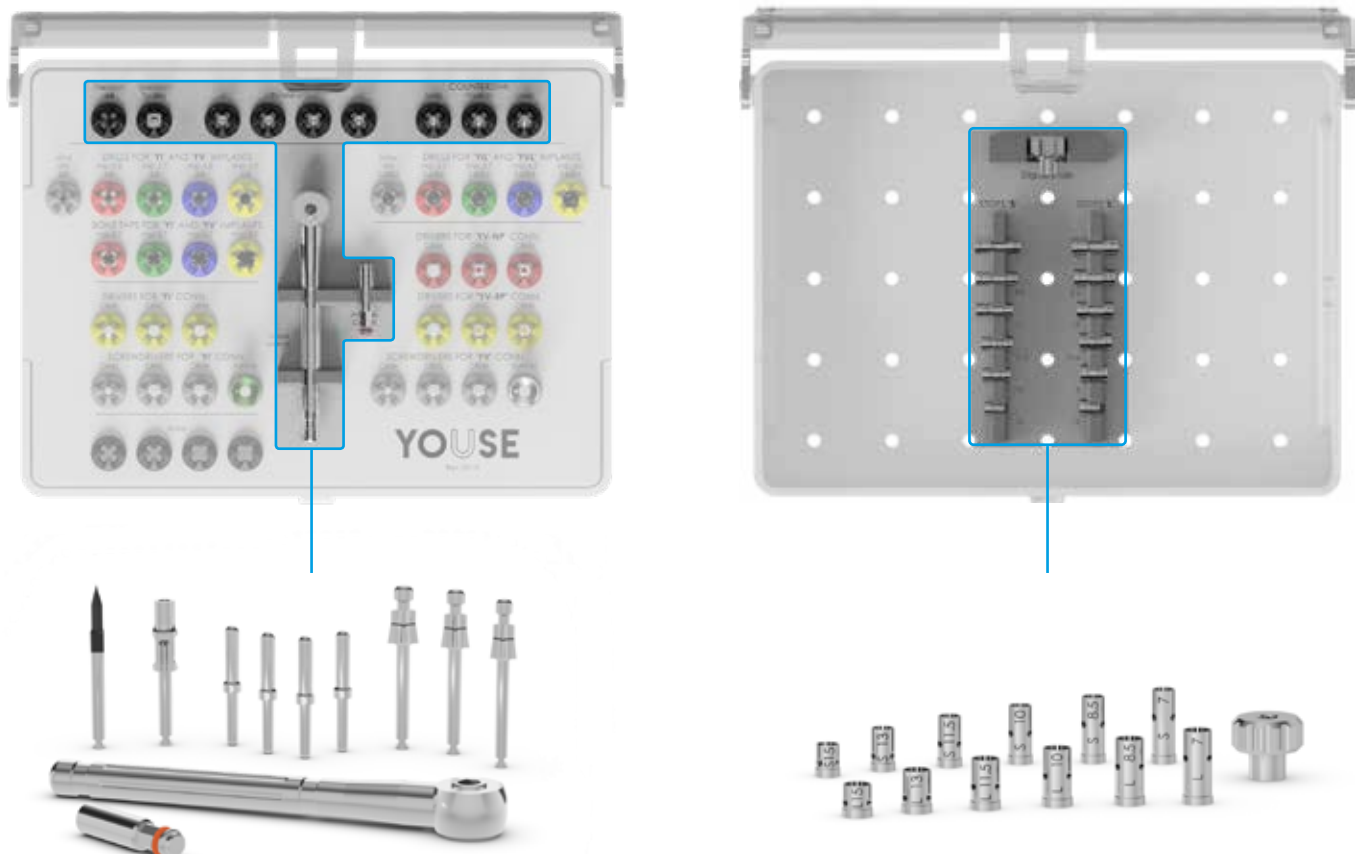

OPTIONAL SUPPLEMENTARY SETS

It is possible to supplement the basic kit with just the instrument modules required to manage the type of implant body and connection chosen. Below are details of the four supplementary sets available for Youse implants (two relating to the implant body, two relating to the connection type):

Supplementary set for preparing narrow thread implants YOUSE-I and YOUSE-V (code Y-SET-F)

Includes drills and bone taps.



Supplementary set for preparing YOUSE-IL and YOUSE-VL large thread implants (code Y-SET-FL)

Includes step drills.

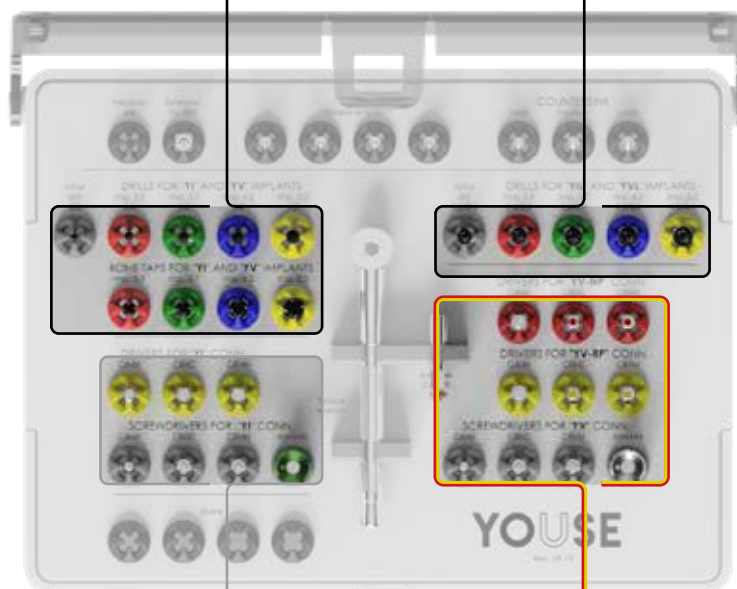

Supplementary set for insertion of implants with internal hex connection YOUSE-I and YOUSE-IL (code YI-SET-ACC)

Contains drivers for the insertion of implants with internal hexagonal connection, and the corresponding prosthetic screwdrivers with hexagonal key.



Supplementary set for insertion of implants with conical connection YOUSE-V and YOUSE-VL (code YV-SET-ACC)

Contains drivers for the insertion of implants with conical connection with both N and with R profile and the corresponding prosthetic screwdrivers with torx key.

SURGICAL SEQUENCES

Sequence for truncated conical implants YOUSE-I and YOUSE-V with narrow thread

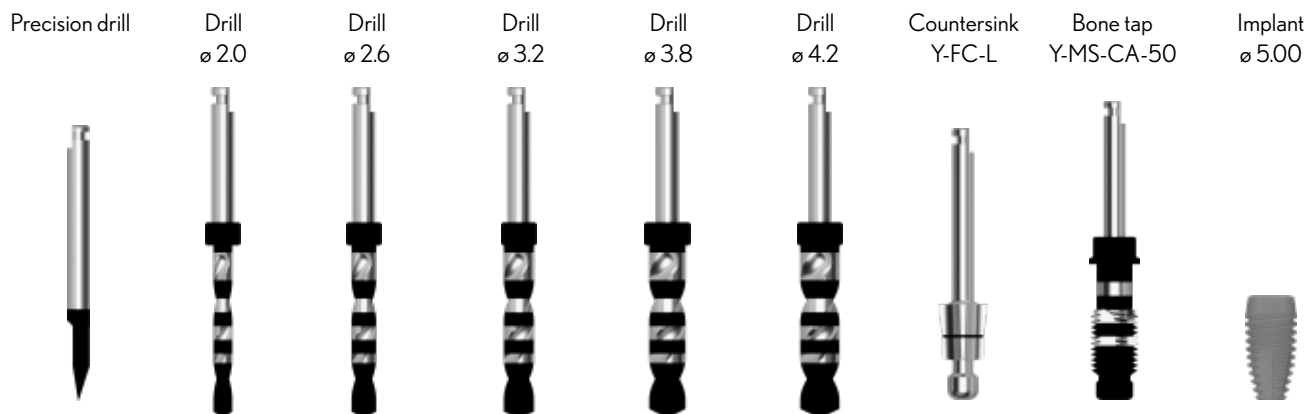

The illustrative graphic sequence refers to the preparation for the ø 5.00 mm narrow thread Youse implant.

ø body	ø 3.30	ø 3.75	ø 4.20	ø 5.00
Sequence	Precision drill	Precision drill	Precision drill	Precision drill
	Drill 2.0	Drill 2.0	Drill 2.0	Drill 2.0
	Drill 2.6	Drill 2.6	Drill 2.6	Drill 2.6
	Countersink S (Bone tap 3.3)	Drill 3.2	Drill 3.2	Drill 3.2
		Countersink M (Bone tap 3.7)	Drill 3.8	Drill 3.8
			Countersink M (Bone tap 4.2)	Drill 4.2
				Countersink L (Bone tap 5.0)

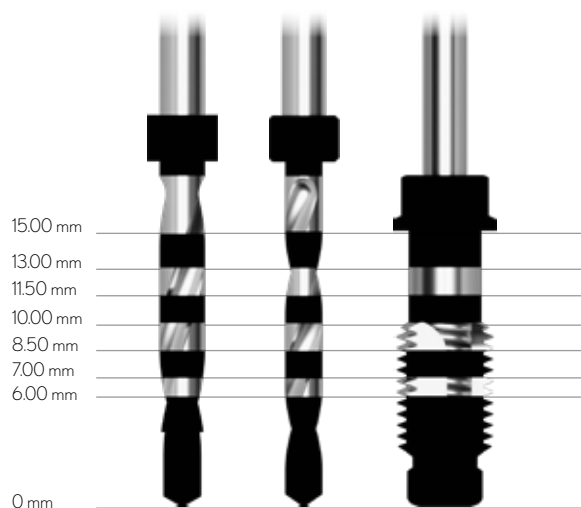

Correspondence between preparation length and laserised marks. Please note that the indicated lengths always include the tip of the drills.

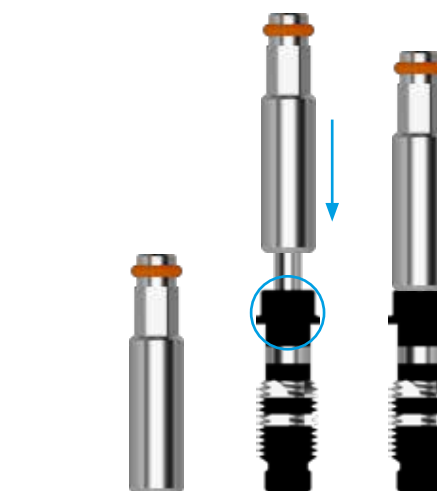

The Y-CONV-CA-CRI connector in the basic surgical kit base, also makes the bone taps usable with the ratchet by engaging the hexagon at the base of the bone taps.

ATTENTION: the Y-CONV-CA-CRI connector is non-retentive, it must be positioned on the tapping hexagon once the latter has already been positioned in the mouth with the contra-angle handpiece, in order to carry out the last tapping manoeuvres with the ratchet in a more controlled manner and in case a higher torque is required.

Recommended torque for implant insertion: 50-60 Ncm. The sequences refer to an insertion in medium quality bone. The use of the countersink drill is always recommended in order to obtain a suitable preparation and prevent coronal compression; in the case of highly represented cortical bone, the use of the. If the quality of the bone to be prepared is particularly poor, it is recommended to opt for a subpreparation protocol, stopping with the previous drill than the one indicated as the final in the sequence.

Sequence for tapered YOUSE-IL and YOUSE-VL large thread implants

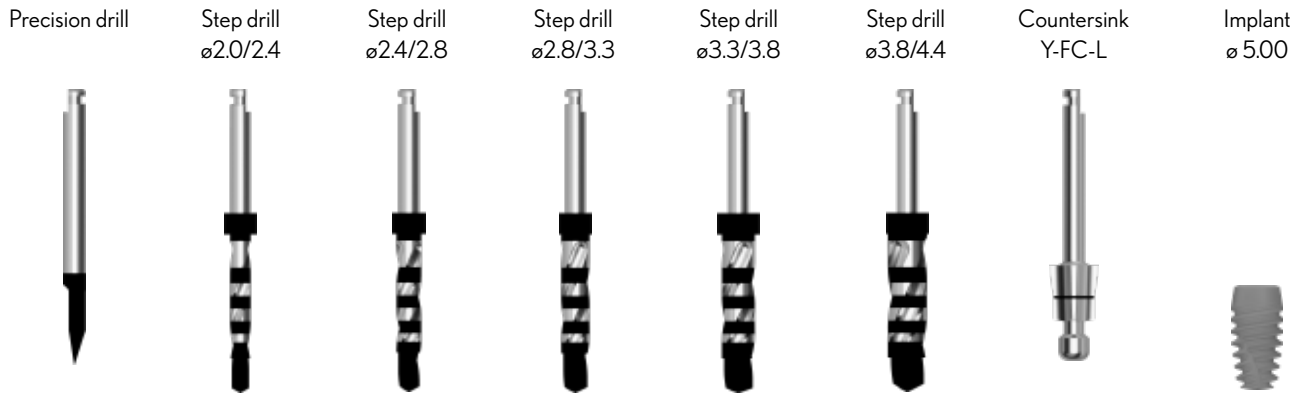

The illustrative graphic sequence refers to the preparation for the ø 5.00 mm wide thread Youse implant.



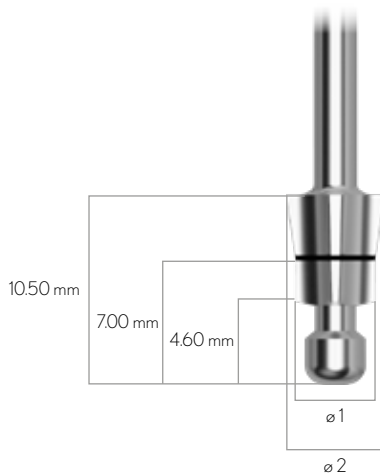



ø body	ø 3.30	ø 3.75	ø 4.20	ø 5.00
Sequence	Precision drill	Precision drill	Precision drill	Precision drill
	Step drill 2.0/2.4	Step drill 2.0/2.4	Step drill 2.0/2.4	Step drill 2.0/2.4
	Step drill 2.4/2.8	Step drill 2.4/2.8	Step drill 2.4/2.8	Step drill 2.4/2.8
	Countersink S	Step drill 2.8/3.3	Step drill 2.8/3.3	Step drill 2.8/3.3
		Countersink M	Step drill 3.3/3.8	Step drill 3.3/3.8
			Countersink M	Step drill 3.8/4.4
				Countersink L





Notch references and diameters of countersink S, M and L.





ø body	S	M	L
ø1	3.50 mm	4.00 mm	5.00 mm
ø2	5.00 mm	5.00 mm	6.00 mm

















Recommended torque for implant insertion: 50-60 Ncm. The sequences refer to an insertion in medium quality bone. The use of the countersink drill is always recommended in order to obtain a suitable preparation and prevent coronal compression; in the case of highly represented cortical bone, the use of the. If the quality of the bone to be prepared is particularly poor, it is recommended to opt for a subpreparation protocol, stopping with the previous drill than the one indicated as the final in the sequence.

Surgical instruments		
stop key ratchet		Y-CRI-FIX
manual connector		Y-CONV-CRI-MAN
connector		Y-CONV-CA-CRI
manual handle		Y-MAN*
parallelism pin		Y-PERNO
extension for drills		Y-F-EXT

* Optional instruments, not included in the kit, can be ordered separately







Countersink drills		
countersink S		Y-FC-S
countersink M		Y-FC-M
countersink L		Y-FC-L

Bone taps		
contra angle 3.30		Y-MS-CA-33
contra angle 3.70		Y-MS-CA-37
contra angle 4.20		Y-MS-CA-42
contra angle 5.00		Y-MS-CA-50



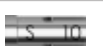



Drills			
	h (mm)		
precision drill			Y-F-LAN
step drill	2.0/2.4		Y-F-20-24
	2.4/2.8		Y-F-24-28
	2.8/3.3		Y-F-28-33
	3.3/3.8		Y-F-33-38
	3.8/4.4		Y-F-38-44
cylindrical drill	short 2.0		Y-F-20*
	long 2.0		Y-F-20-L
	short 2.6		Y-F-26*
	long 2.6		Y-F-26-L
	short 3.2		Y-F-32*
	long 3.2		Y-F-32-L
	short 3.8		Y-F-38*
	long 3.8		Y-F-38-L
	short 4.2		Y-F-42*
	long 4.2		Y-F-42-L

* Please note that short cylindrical drills are not equipped with stop, so they cannot be combined with S and L stop and are suitable for distal sectors.





Also, they are optional instruments, not included in the kit, can be ordered separately.

Stop S**		
for drill, L 7 mm		Y-ST-S-07
for drill, L 8 mm		Y-ST-S-08
for drill, L 10 mm		Y-ST-S-10
for drill, L 11 mm		Y-ST-S-11
for drill, L 13 mm		Y-ST-S-13
for drill, L 15 mm		Y-ST-S-15

**Stop S must be used with drills up to diameter 3.30 mm (Y-F-20-24, Y-F-24-28, Y-F-28-33, Y-F-20-L, Y-F-26-L, Y-F-32-L)

Stop L***		
for drill, L 7 mm		Y-ST-L-07
for drill, L 8 mm		Y-ST-L-08
for drill, L 10 mm		Y-ST-L-10
for drill, L 11 mm		Y-ST-L-11
for drill, L 13 mm		Y-ST-L-13
for drill, L 15 mm		Y-ST-L-15







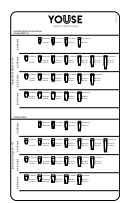









***Stop L must be used with drills from diameter 3.30 mm (Y-F-33-38, Y-F-38-44, Y-F-38-L, Y-F-42-L)

Diamond drills for socket preparation		
diamond drill 3.20 mm		Y-FD-32
diamond drill 3.20 mm, long		Y-FD-32-L
diamond drill 3.70 mm		Y-FD-37
diamond drill 3.70 mm, long		Y-FD-37-L







Optional instrument not included in the kit, can be ordered separately

X-ray templates		
real dimensions		Y-L100
dimensions increased by 20%		Y-L120
dimensions increased by 30%		Y-L130





Optional instrument not included in the kit, can be ordered separately

Countersink drills				
transgingival h 3.00, wide				
ø 3.30 	ø 3.75 	ø 4.20 	ø 5.00 	
				
A-PAD-PS330-L	A-PAD-PS380-L	A-PAD-PS425-L	A-PAD-PS500-L	
transgingival h 5.00, narrow				
ø 3.30 	ø 3.75 	ø 4.20 	ø 5.00 	
				
A-PAD-PS330-S	A-PAD-PS380-S	A-PAD-PS425-S	A-PAD-PS500-S	







Optional instrument not included in the kit, can be ordered separately

Bone profiler guides		
YOUSE I 	YOUSE V narrow 	YOUSE V regular 
		
YI-GUI-PS	YV-N-GUI-PS	YV-R-GUI-PS

Optional instrument not included in the kit, can be ordered separately

Implant drivers			
	YOUSE I 	YOUSE V narrow 	YOUSE V regular 
right angle shank driver extra short		-	
right angle shank driver short	YI-DR-CA-C*	YV-DR-N-CA-XC*	YV-DR-R-CA-XC*
right angle shank driver middle	YI-DR-CA-M	YV-DR-N-CA-C*	YV-DR-R-CA-C*
right angle shank driver long	YI-DR-CA-L*	YV-DR-N-CA-M	YV-DR-R-CA-M
driver for ratchet extra short	YI-DR-CRI-XC*	YV-DR-N-CA-L*	YV-DR-R-CA-L*
driver for ratchet short	YI-DR-CRI-C	YV-DR-N-CRI-XC*	YV-DR-R-CRI-XC*
driver for ratchet middle	YI-DR-CRI-M	YV-DR-N-CRI-C	YV-DR-R-CRI-C
		YV-DR-N-CRI-M	YV-DR-R-CRI-M

*Optional instrument not included in the kit, can be ordered separately

Screwdrivers			
	YOUSE I 	YOUSE V narrow 	YOUSE V regular 
manual screwdrivers short			YV-CV-MAN-C*
manual screwdrivers middle	YI-CV-MAN-C*		YV-CV-MAN-M
manual screwdrivers long	YI-CV-MAN-M		YV-CV-MAN-L*
contra-angle screwdrivers short	YI-CV-MAN-L*		YV-CV-CA-C*
contra-angle screwdrivers middle	YI-CV-CA-C*		YV-CV-CA-M
contra-angle screwdrivers long	YI-CV-CA-M		-
ratchet screwdriver short	YI-CV-CA-L*		YV-CV-CRI-C
ratchet screwdriver middle	YI-CV-CRI-C		YV-CV-CRI-M
ratchet screwdriver long	YI-CV-CRI-M		-
	YI-CV-CRI-L*		

Optional instrument not included in the kit, can be ordered separately

Screwdrivers have a different tip depending on the prosthetic connection for which they are used: Youse I screwdrivers have a tip Hex, Youse V screwdrivers have torx tip.















Macrodetail of the prosthetic screw Youse I, with engagement hexagonal.







Macrodetail of the prosthetic screw Youse V, with torx engagement.





Healing abutments

Whit straight emergency						
h (mm)	YOUSE I 		YOUSE V narrow 		YOUSE V regular 	
1.00		YI-TG-01		YV-N-TG-01		YV-R-TG-01
3.00		YI-TG-03		YV-N-TG-03		YV-R-TG-03
4.00		YI-TG-04		YV-N-TG-04		YV-R-TG-04
5.00		YI-TG-05		YV-N-TG-05		YV-R-TG-05
7.00		YI-TG-07		YV-N-TG-07		YV-R-TG-07

Whit anatomical emergence						
h (mm)	YOUSE I 		YOUSE V narrow 		YOUSE V regular 	
2 mm		YI-TG-A2		YV-N-TG-A2		YV-R-TG-A2
3 mm		YI-TG-A3		YV-N-TG-A3		YV-R-TG-A3
5 mm		YI-TG-A5		YV-N-TG-A5		YV-R-TG-A5
7 mm		YI-TG-A7		YV-N-TG-A7		YV-R-TG-A7

Impression and model phase

Analog						
	YOUSE I 		YOUSE V narrow 		YOUSE V regular 	
		YI-ANA		YV-N-ANA		YV-R-ANA







Pick-up transfer						
	YOUSE I 		YOUSE V narrow 		YOUSE V regular 	
		YI-TRA-P		YV-N-TRA-P-01		YV-R-TRA-P-01
		-		YV-N-TRA-P-03		YV-R-TRA-P-03



Transfer pick-ups are supplied with the corresponding transfer screws (which can also be ordered separately under the codes YV-N-VTRA, YV-R-VTRA or YI-VTRA depending on the connection).



Pull-up transfer						
	YOUSE I 		YOUSE V narrow 		YOUSE V regular 	
		YI-TRA-S		YV-N-TRA-S		YV-R-TRA-S



Pull-up transfers are supplied with standard prosthetic screws (can also be ordered separately with the codes YV-N-VP, YV-R-VP or YI-VP depending on the connection).

Prosthetic components for CAD-CAM protocols

Scanbody			
	YOUSE I 	YOUSE V narrow 	YOUSE V regular 
	YI-SB-DIG		YV-N-SB-DIG
			YV-R-SB-DIG

Digital analog			
	YOUSE I 	YOUSE V narrow 	YOUSE V regular 
	YI-ANA-DIG		YV-N-ANA-DIG
			YV-R-ANA-DIG

T-Base				
	h (mm)	YOUSE I 	YOUSE V narrow 	YOUSE V regular 
Repositionable	1.00	YI-TB-01	YV-N-TB-01	YV-R-TB-01
	3.00	YI-TB-03	YV-N-TB-03	YV-R-TB-03
Rotating	1.00	YI-TB-01-NX	YV-N-TB-01-NX	YV-R-TB-01-NX
	3.00	YI-TB-03-NX	YV-N-TB-03-NX	YV-R-TB-03-NX

T-Unica				
	h (mm)	YOUSE I 	YOUSE V narrow 	YOUSE V regular 
Repositionable	1.00	YI-TC-UNI-01	YV-N-TC-UNI-01	YV-R-TC-UNI-01
	2.00	YI-TC-UNI-02	YV-N-TC-UNI-02	YV-R-TC-UNI-02
	3.00	YI-TC-UNI-03	YV-N-TC-UNI-03	YV-R-TC-UNI-03
	4.00	YI-TC-UNI-04	YV-N-TC-UNI-04	YV-R-TC-UNI-04
Rotating	1.00	YI-TC-UNI-01-ROT	YV-N-TC-UNI-01-ROT	YV-R-TC-UNI-01-ROT
	2.00	YI-TC-UNI-02-ROT	YV-N-TC-UNI-02-ROT	YV-R-TC-UNI-02-ROT
	3.00	YI-TC-UNI-03-ROT	YV-N-TC-UNI-03-ROT	YV-R-TC-UNI-03-ROT
	4.00	YI-TC-UNI-04-ROT	YV-N-TC-UNI-04-ROT	YV-R-TC-UNI-04-ROT

Cutting guide and holder for Unica T-Connect

unique platform



TC-UNI-HOLD4-SX Cutting guide holder S (small) for Unica T-connect left side

TC-UNI-HOLD6-DX Cutting guide holder L (large) for Unica T-connect right side

TC-UNI-HOLD4-DX Cutting guide holder S (small) for Unica T-connect right side

TC-UNI-HOLD6-SX Cutting guide holder L (large) for Unica T-connect left side

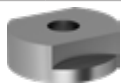

TC-UNI-DIMA-H4 4 mm cutting guide for Unica T-Connect

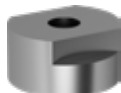

TC-UNI-DIMA-H6 6 mm cutting guide for Unica T-Connect



TC-UNI-DIMA-ANG Cutting guide for angled hole for T-Connect Unica

Unica T-Connect accessories

unique platform



TC-UNI-ORING Intraoral testing O-ring for T-Connect Unica



TC-UNI-CC Castable sleeve for T-Connect, rotating



TC-UNI-CC-S Small castable sleeve for Unica T-Connect, repositionable



TC-UNI-CC-L Large castable sleeve for Unica T-Connect, repositionable



C-UNI-ORING-INS O-Ring inserter



See how easy it is to precisely customize the T-Connect Unica with the cutting guides and the corresponding holder.

Premilled post in titanium

YOUSE I



YI-PMT15-10

YOUSE V narrow





YV-N-PMT15-10



YOUSE V regular





YV-R-PMT15-10



Traditional prostheses components

Provisional post				
	h (mm)	YOUSE I 	YOUSE V narrow 	YOUSE V regular 
Repositionable	1.00	YI-PRO-TIT	YV-N-PRO-01	YV-R-PRO-01
	3.00	-	YV-N-PRO-03	YV-R-PRO-03
Rotating	1.00	YI-PRO-TIT-NX	YV-N-PRO-01-NX	YV-R-PRO-01-NX
	3.00	-	YV-N-PRO-03-NX	YV-R-PRO-03-NX





Straight post				
	h (mm)	YOUSE I 	YOUSE V narrow 	YOUSE V regular 
Repositionable	1.00	YI-MD	YV-N-MD-01	YV-R-MD-01
	3.00	-	YV-N-MD-03	YV-R-MD-03





Angled post				
	h (mm)	YOUSE I 	YOUSE V narrow 	YOUSE V regular 
Repositionable Angled at 15°	1.50	YI-MA15	YV-N-MA15-01	YV-R-MA15-01
	3.00	-	YV-N-MA15-03	YV-R-MA15-03
Repositionable Angled at 25°	1.50	YI-MA25	YV-N-MA25-01	YV-R-MA25-01
	3.00	-	YV-N-MA25-03	YV-R-MA25-03

Custom post				
		YOUSE I 	YOUSE V narrow 	YOUSE V regular 
Repositionable		YI-MD-F	YV-N-MD-F-01	YV-R-MD-F-01
		-	YV-N-MD-F-03	YV-R-MD-F-03

Castable post with cromo cobalto base				
	h (mm)	YOUSE I 	YOUSE V narrow 	YOUSE V regular 
Repositionable	1.50	YI-CR	YV-N-CR-01	YV-R-CR-01
	3.00	-	YV-N-CR-03	YV-R-CR-03
Rotating	1.50	YI-CR-NX	YV-N-CR-01-NX	YV-R-CR-01-NX
	3.00	-	YV-N-CR-03-NX	YV-R-CR-03-NX



The traditional prosthesis is supplied with standard prosthetic screws (which can also be ordered separately under the codes YV-N-VP, YV-R-VP or YI-VP depending on the connection).

Fully castable post				
		YOUSE I 	YOUSE V narrow 	YOUSE V regular 
Repositionable		YI-CAL	-	-
Rotating		YI-CAL-NX	-	-

PLAIN abutment				
h (mm)		YOUSE I 	YOUSE V narrow 	YOUSE V regular 
1.00		YI-PLAIN-M-1	YV-N-PLAIN-M-1	YV-R-PLAIN-M-1
2.00		YI-PLAIN-M-2	YV-N-PLAIN-M-2	YV-R-PLAIN-M-2
3.00		YI-PLAIN-M-3	YV-N-PLAIN-M-3	YV-R-PLAIN-M-3
4.00		-	YV-N-PLAIN-M-4	YV-R-PLAIN-M-4









PLAIN accessories		
unique platform		
	A-PLAIN-CG380	healing cap
	A-PLAIN-CC380	castable sleeve
	A-PLAIN-CT380	Gr. 5 titanium sleeve
	A-PLAIN-TRA-380	Pick-up transfer
	A-PLAIN-ANA-380	analog















Castable and titanium sleeves: A-PLAIN-VP200 fixation screw included.
 Pick-up transfers: A-PLAIN-VTRA200 fixation screw included.

Digital components for PLAIN abutment		
unique platform		
	A-INT-CAMTRA-PLAIN-L	scanbody
	A-PLAIN-ANA-330-DIG	digital analog



Scanbody: A-PLAIN-VP200 fixation screw included.
 Digital analog: VADIG-180 fixation screw included.







Solutions for screw retained prostheses: AV system



Straight abutments					
h (mm)		YOUSE I 		YOUSE V narrow 	YOUSE V regular 
1.00		YI-AVD-01		YV-N-AVD-01	YV-R-AVD-01
2.00		YI-AVD-02		YV-N-AVD-02	YV-R-AVD-02
3.00		YI-AVD-03		YV-N-AVD-03	YV-R-AVD-03

Angled abutments							
	h (mm)	YOUSE I 		YOUSE V narrow 	YOUSE V regular 		
Angled at 17°	2.00		YI-AVA17-02		YV-N-AVA17-02		YV-R-AVA17-02
	3.00		YI-AVA17-03		YV-N-AVA17-03		YV-R-AVA17-03
Angled at 30°	3.00		YI-AVA30-03		YV-N-AVA30-03		YV-R-AVA30-03
	4.00		YI-AVA30-04		YV-N-AVA30-04		YV-R-AVA30-04

Angled posts for screw-retained prostheses are supplied with the corresponding AVA screws (can also be ordered separately with the codes YV-N-AVA-VTP, YV-R-AVA-VTP or YI-AVA-VTP depending on the connection).

Screwdrivers for posts for screw retained prostheses		
	Y-CV-AVD-CA	AV contra angle screwdriver
	Y-CV-AVD-CRI	AV ratchet screwdriver







Traditional components for superstructures on AV abutments		
unique platform		
	Y-AVV-TG-04	Healing abutment, low
	Y-AVV-TG-08	Healing abutment, high
	Y-AVV-TRA	Transfer
	Y-AVV-ANA	Analog
	Y-AVV-CT-RIT	Titanium cylinder with flaps
	Y-AVV-CT-NORIT	Smooth titanium cylinder
	Y-AVV-CAL	Castable cylinder

Digital components for superstructures on AV abutments		
unique platform		
	Y-AVV-SB-DIG	Scanbody
	Y-AVV-ANA-DIG	Digital analog
	Y-AVV-TCA	T-base for angled screw-hole*



















* Y-AV-VTP-14 screw included, can be used also with screw for angled hole 41.314.039.01-2 (screwdriver DSPDCLH-24 or DSPDCLH-32)

Y-AV-VTP-14 screw included







Solutions for conometric prosthesis: ORBIT system

ORBIT posts						
h (mm)	YOUSE I 		YOUSE V narrow 		YOUSE V regular 	
1.50		SPHIZ1*		SPHIN1*		SPHIN5*
3.00		SPHIZ3*		SPHIN3*		SPHIN7*







* the ORBIT abutment pack includes 1 abutment and 1 LEM orientable component

ORBIT accessories		
unique platform		
	3CMC	Prosthetic screwdriver 1.2 mm, short
	3ILEM	LEM driver
	PAR	Parallelizer LEM
	4ICIC	Implant driver
	TCC	Closed-tray transfer
	TCA	Open-tray transfer
	MSD	Scanbody for LEM
	ANL	Analog for LEM
	HC1	Healing cap for LEM
	CLCAE	LEM conometric cap-rep
	CLCRE	LEM conometric cap-rot
	CLCRRE	LEM conometric cap for resin-rot
	CLAA	LEM conometric cap for screw retained-rep
	CLAR	LEM conometric cap for screw retained-rot
	CLCRW	LEM conometric cap for intraoral welding-rot
	WINGS	LEM conometric cap for intraoral welding with wings-rot
	TCAV	Prosthetic screw for analog
	VCA	Prosthetic screw for LEM cap

Solutions for overdenture













Ball attachments			
h (mm)	YOUSE I 	YOUSE V narrow 	YOUSE V regular 
1.00	YI-SFE-01	YV-N-SFE-01	YV-R-SFE-01
2.00	 YI-SFE-02	 YV-N-SFE-02	 YV-R-SFE-02
3.00	YI-SFE-03	YV-N-SFE-03	YV-R-SFE-03
4.00	YI-SFE-04	YV-N-SFE-04	YV-R-SFE-04

For the placement of ball attachments the connector Y-CONV-CA-CRI must be used.

Caps for ball attachments		
unique platform		
	CAP-TFL-1	polyamide cap
	CONT-CAP-TFL-1	steel container for polyamide cap external diameter \varnothing 4.80 mm
	CAP-TIT-1	Gr. 5 titanium cap with cap in two parts, retention spring titanium and plastic, plastic mounting ring
	AN-CAP-TIT-1	spare plastic ring
	MOL1-CAP-TIT-1	spare steel spring, average hardness
	MOL2-CAP-TIT-1	spare steel spring, soft
	CAP-1	gold alloy cap, with 3 plastic rings and a tin spacer for the lab

OT Equator*			
h (mm)	YOUSE I 	YOUSE V narrow 	YOUSE V regular 
1.00	130YI1	130YVN1	130YVR1
2.00	130YI2	130YVN2	130YVR2
3.00	130YI3	130YVN3	130YVR3
4.00	130YI4	130YVN4	130YVR4
5.00	130YI5	130YVN5	130YVR5
6.00	130YI6	130YVN6	130YVR6

*The codes refer to the pack complete with 1 OT EQUATOR post, 4 assorted retention caps, 1 steel cap container and 1 protective disc.

OT Equator accessories		
unique platform		
	144AEY	Analog
	044CAINY	Transfer
	140CEVY	Retention cap: purple (4 pcs), high retention, (2700 g)
	140CETY	Retention cap: white (4 pcs), standard retention (1800 g)
	140CERY	Retention cap: pink (4 pcs), soft retention (1200 g)
	140CEGY	Retention cap: yellow (4 pcs), extra soft retention (600 g)
	140CENY	Retention cap: black (4 pcs), laboratory use
	140CAEY	Steel container for cap
	330SBEY*	Smartbox container with black cap
	100PDY	Protective disc
	485ICEY	Caps insertion/extraction
	774CQAET	Screwdriver

* Smart Box self-parallelising container for Ot Equator, contains: 1 smart box with black positioning cap, 1 pink protective disc, 4 assorted retentive caps (yellow, pink, white, purple).

GUIDED YOUSE

Guided surgery kit

















The Guided Youse kit is specially designed to enable a simple and intuitive computer-assisted approach intuitive approach to surgery with Youse implants. Similar to the traditional kit, Guided Youse includes a basic set-up and four additional set-ups additional fittings, which can be combined depending on the type of implant chosen.

You can purchase the instrument tray with the code Y-CG-TRAY.



The Guided Youse kit includes all the surgical preparation instruments and assemblies for guided insertion of the Youse implants. For sleeves and surgical guides please refer to Sweden & Martina's Digital Service Centre. Sweden & Martina produces a series of standard, non-indexed sleeves available for laboratories that make surgical guides and a series of indexed sleeves with an upper hexagon, which enables the positioning of the connection previously planned implant connection. Precisely because of this peculiarity, these are positioned in the surgical guides produced by Sweden & Martina thanks to special software.



Guide sleeves				
	YOUSE I		YOUSE V	
h (mm)	ø 3.75	ø 4.20 - 5.00	ø 3.30	4.20 - 5.00
5.00	 5.00  GS-B415	 5.00  GS-B550	 5.00  GS-B415	 5.00  GS-B550
4.00	 4.00  GS-B415-EX-6*	 4.00  GS-B550-EX-6*	 4.00  GS-B415-EX-6*	 4.00  GS-B550-EX-6*

*Indexed guide sleeves are available in packs of 6, not individually.

Attention: whenever a 3D printer is available to make the templates, it is appropriate to use the flow to bond the sleeves and not use cyano-methacrylate because the latter tends to oxidize them.

Basic equipment (code Y-CG-KIT)

1
Mucotome for 4.15 sleeve
 Y-CG-MUC-41



2
Bone profiler for 4.15 sleeve
 Y-CG-LC-41



3
Initial drill for sleeve 4.15
 Y-CG-FI-41



4
Mucotome for 5.50 sleeve
 Y-CG-MUC-55



5
Bone profiler for 5.50 sleeve
 Y-CG-LC-55



6
Initial drill for sleeve 5.50
 Y-CG-FI-55

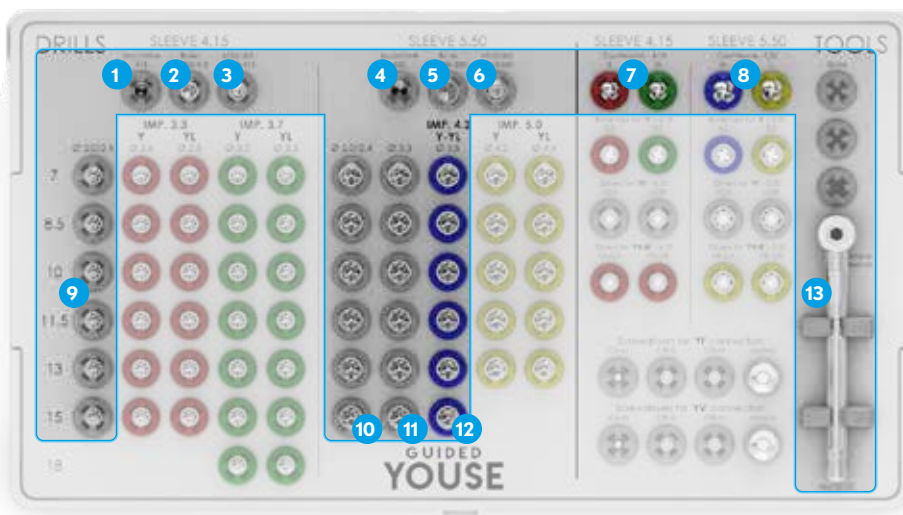

13
Ratchet
 Y-CRI-FIX



7
Countersink for sleeve 4.15
 Y-CG-FCS-33-41
 Y-CG-FCS-37-41



8
Countersink for sleeve 5.50
 Y-CG-FCS-42-55
 Y-CG-FCS-50-55



9
Drill 2.0/2.4 (sleeve 4.15)
 Y-CG-F24-07-41
 Y-CG-F24-08-41
 Y-CG-F24-10-41
 Y-CG-F24-11-41
 Y-CG-F24-13-41
 Y-CG-F24-15-41



10
Drill 2.0/2.4 (sleeve 5.50)
 Y-CG-F24-07-55
 Y-CG-F24-08-55
 Y-CG-F24-10-55
 Y-CG-F24-11-55
 Y-CG-F24-13-55
 Y-CG-F24-15-55



11
Drill 3.3 (sleeve 5.50)
 Y-CG-F33-07-55
 Y-CG-F33-08-55
 Y-CG-F33-10-55
 Y-CG-F33-11-55
 Y-CG-F33-13-55
 Y-CG-F33-15-55



12
Drill 3.8 (sleeve 5.50)
 Y-CG-F38-07-55
 Y-CG-F38-08-55
 Y-CG-F38-10-55
 Y-CG-F38-11-55
 Y-CG-F38-13-55
 Y-CG-F38-15-55



OPTIONAL SETS

Additional set for guided preparation of YI and YV narrow thread implants (code Y-CG-SET-F)

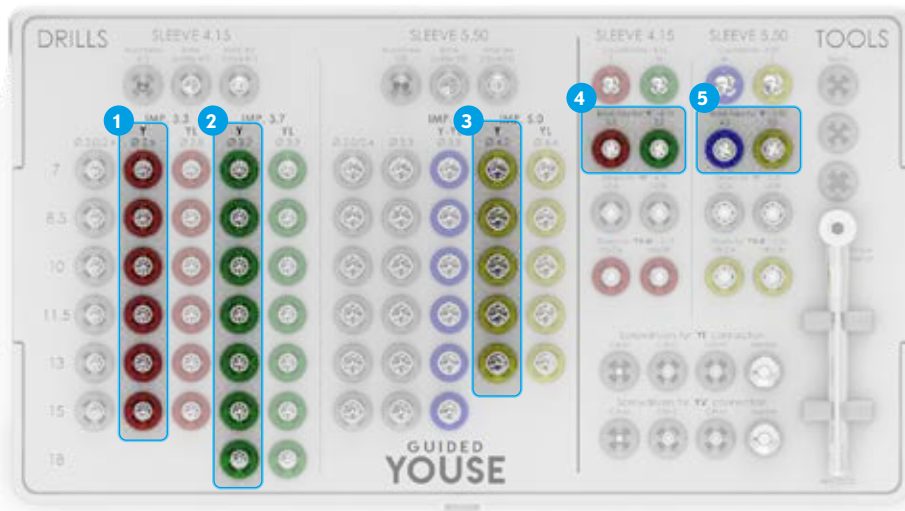

Additional set for guided preparation of YIL and YVL wide thread (code Y-CG-SET-FL)

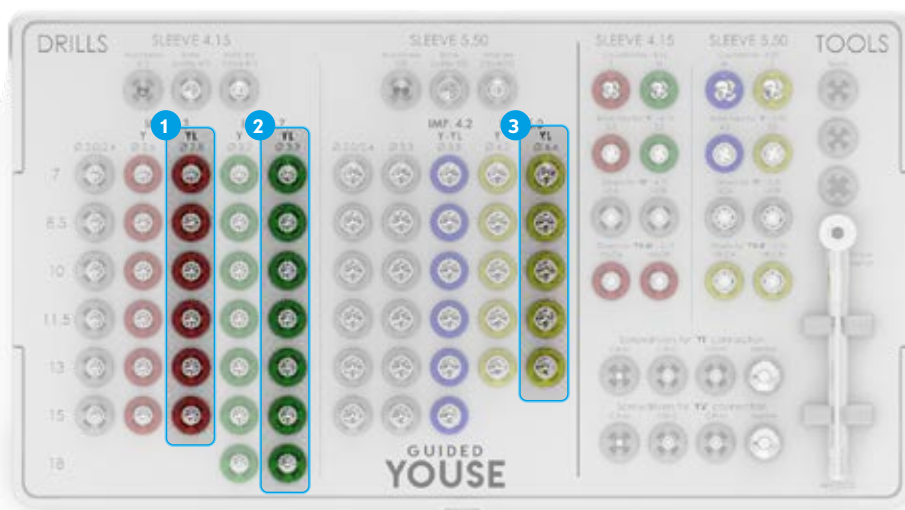

Supplementary set for guided insertion of implants with YI and YIL internal hexagon connection (code Y-CG-I-SET-ACC)

- 1** "I" mounter for contra angle
Y-CG-MOU-I13-41
Y-CG-MOU-I14-55



- 2** "I" mounter for ratchet
Y-CG-MOU-I03-41
Y-CG-MOU-I04-55

- 3** "I" screwdriver for contra angle
YI-CV-CA-M

- 4** "I" Screwdriver for ratchet
YI-CV-CRI-C
YI-CV-CRI-M

- 5** "I" Manual screwdriver
YI-CV-MAN-M

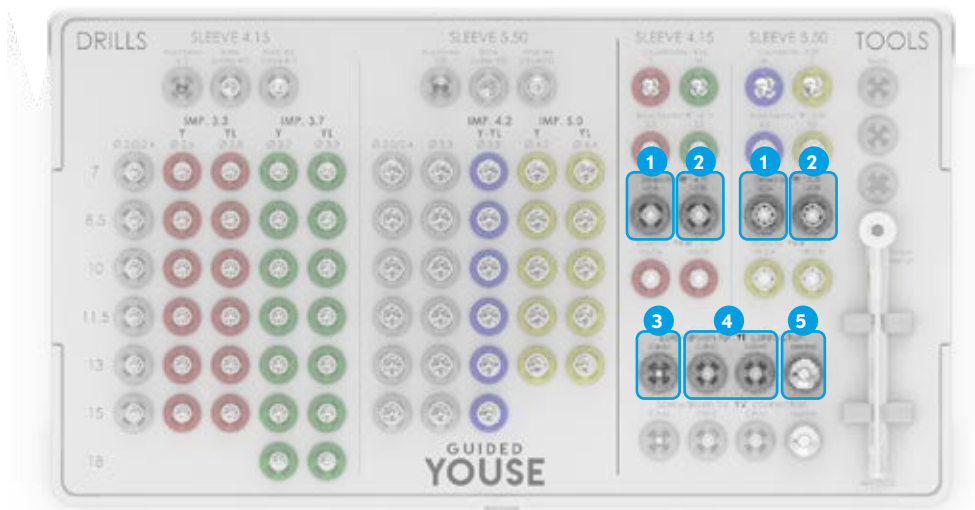



Supplementary set for guided insertion of implants with YV and YVL conical connection (code Y-CG-V-SET-ACC)

- 1** "V" mounter for contra angle
Y-CG-MOU-V13-41
Y-CG-MOU-V14-55



- 2** "V" mounter for ratchet
Y-CG-MOU-V03-41
Y-CG-MOU-V04-55

- 3** "V" screwdriver for contra angle
YV-CV-CA-M

- 4** "V" screwdriver for ratchet
YV-CV-CRI-C
YV-CV-CRI-M

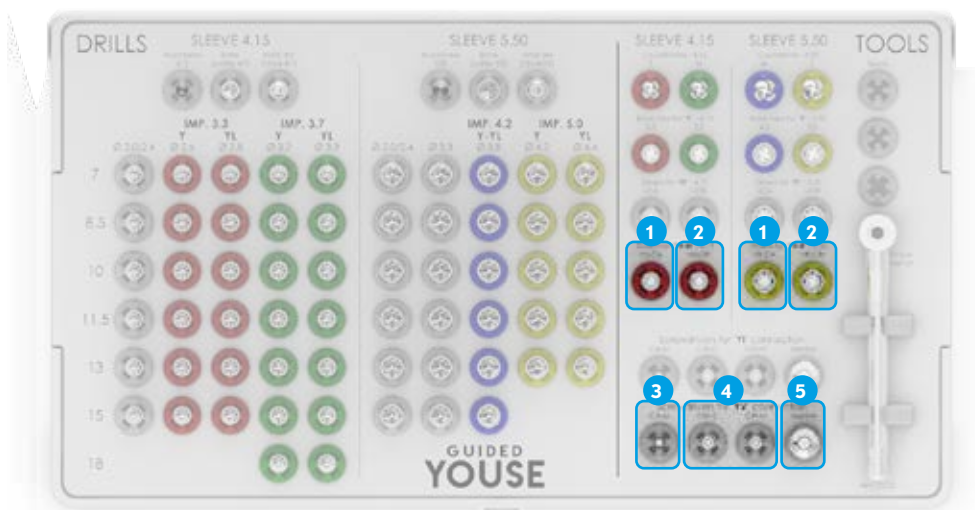

- 5** "V" Manual screwdriver
YV-CV-MAN-M



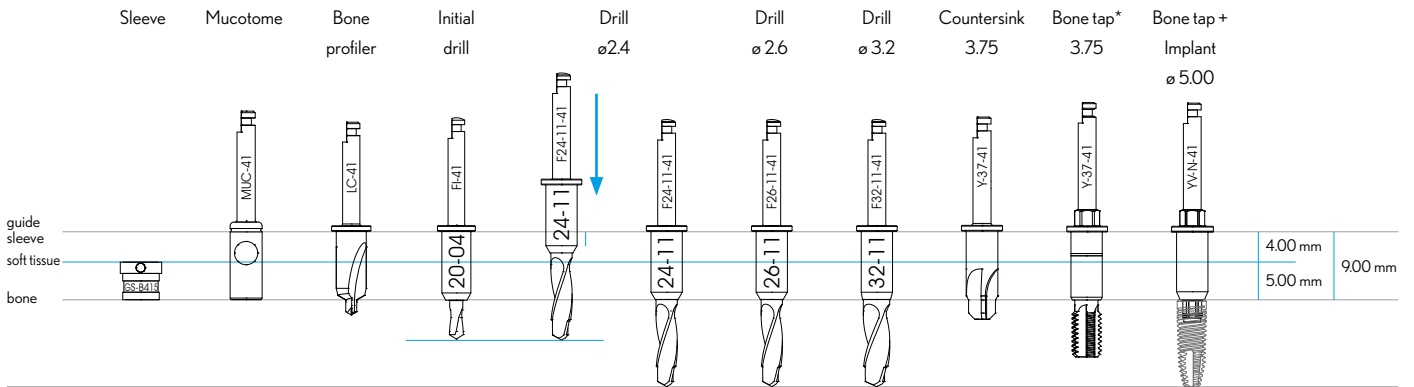

SURGICAL SEQUENCES

The graphic sequence below represents an example of preparation for a narrow Youse implant of 3.75 mm diameter.



* Bone tap are only present in the supplementary set for the preparation of narrow Youse implants.

La sequenza di utilizzo degli strumenti riportata qui sotto è valida per tutti gli impianti della gamma Youse, sia a spira stretta che a spira larga. Gli unici strumenti che differiscono per la spira larga, rispetto a quella stretta, sono riportati tra parentesi nella tabella qui sotto:

ø body	ø 3.30	ø 3.75	ø 4.20	ø 5.00
Sequence	Mucotome	Mucotome	Mucotome	Mucotome
	Bone Profiler	Bone Profiler	Bone Profiler	Bone Profiler
	Initial drill	Initial drill	Initial drill	Initial drill
	Drill 2.0/2.4	Drill 2.0/2.4	Drill 2.0/2.4	Drill 2.0/2.4
	Drill 2.6 (Drill 2.8)	Drill 2.6	Drill 3.3	Drill 3.3
	Countersink 3.3	Drill 3.2 (Drill 3.3)	Drill 3.8	Drill 3.8
	Bone tap 3.3	Countersink 3.75	Countersink 4.2	Drill 4.2 (Drill 4.4)
		Bone tap 3.75	Bone tap 4.2	Countersink 5.0
			Bone tap 5.0	

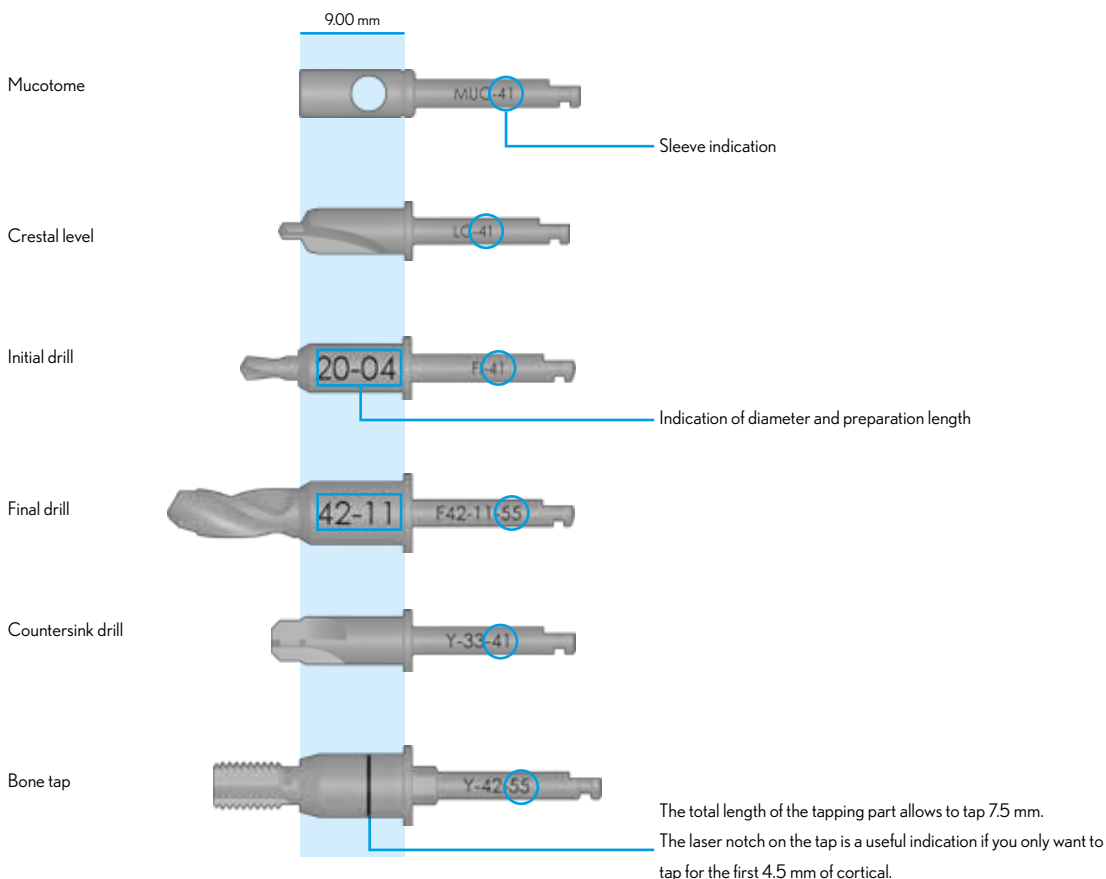



The total length of the tapping part allows to tap 7.5 mm.
The laser notch on the tap is a useful indication if you only want to tap for the first 4.5 mm of cortical.



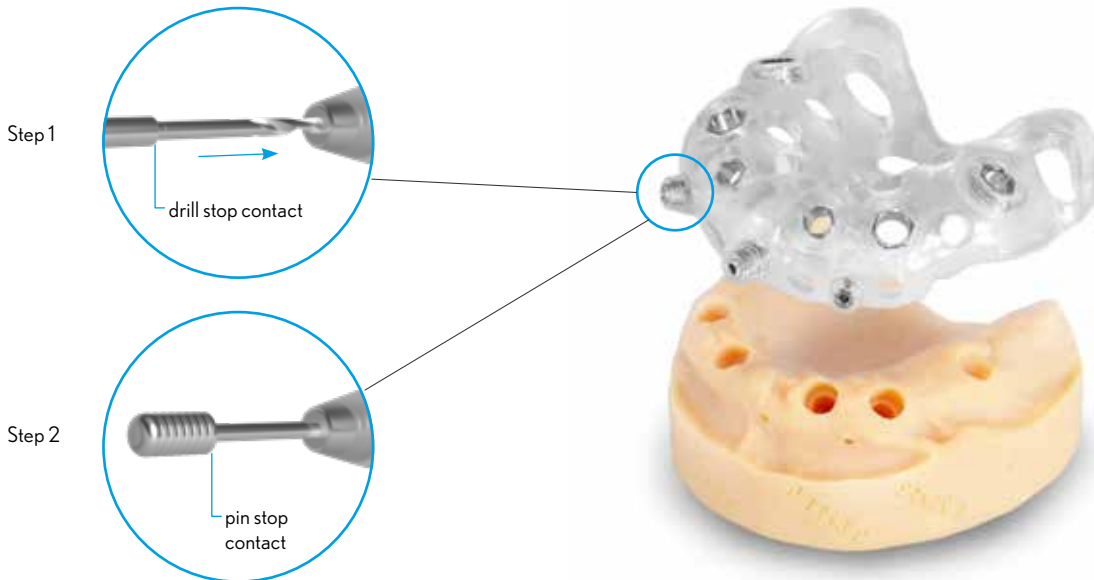





FIXATION PIN AND DRILLS



When the surgical template cannot be stabilized on the residual teeth, it is appropriate to adopt a protocol with a total-thickness flap that guarantees bone support. However, since the edentulous arch would allow tilting, the template needs to be stabilized using the Gr. 5 titanium bone pins included in the kit. In order to prepare the pin's recessed hole, the related GS-FPN-148 drill is provided, to be used at 800 rpm. The pins are guided into the appropriate dedicated sleeves which are provided by Sweden & Martina already inserted in the template without additional cost. Should the templates be made in laboratory, the sleeves can be purchased separately in packs of 6. They are not sold individually.



























Fixation pin and drills		
Drill for fixation pin		GS-FPN-148*
Fixation pin 1 item pack		GS-PIN*
Sleeves for pin 6 item pack		GS-B150-PIN-6*

* Optional instruments, not included in the Guided Youse kit

Optional mounters with passing screw			
	YOUSE I 	YOUSE V narrow 	YOUSE V regular 
	 Y-CG-MOU-I33-41	 Y-CG-MOU-V33-41	 Y-CG-MOU-V42-55
	Y-CG-MOU-I42-55	-	-
optional mounter screws	 Y-CG-VTMOU-I172	 Y-CG-VTMOU-V160	 Y-CG-VTMOU-V200

Easy insert for optional mounters		
Easy Insert drivers for guided surgery mounters, with ratchet shank		EASY4-EX250-EX
Easy Insert drivers for guided surgery mounters, with right-angle shank		EASYC4-EX250-CA

Mounter hand driver		
Mounter hand driver		GS-MOU-DG

Laboratory and prosthetic screws				
	YOUSE I 	YOUSE V narrow 	YOUSE V regular 	
Prosthetic screw	 YI-VP	 YV-N-VP	 YV-R-VP	
Screw transfer Pick-up	 YI-VTRA	 YV-N-VTRA	 YV-R-VTRA	
Prosthetic screw For ava posts	 YI-AVA-VTP	 YV-N-AVA-VTP	 YV-R-AVA-VTP	
Transfer screw*	 Y-AV-VTRA	 Y-AV-VTRA	 Y-AV-VTRA	
Superstructure av screw*	 Y-AV-VTP-14	 Y-AV-VTP-14	 Y-AV-VTP-14	
Screw for angled hole	 41.317.080.01-2	 41.316.082.01-2	 41.320.081.01-2	
screw for angled hole-AV system	 41.314.039.01-2	 41.314.039.01-2	 41.314.039.01-2	

Important: the Y-AV-VTP-14 screw for AV superstructures and its Y-AV-VTRA transfer screw are unique and do not depend on the connection implant choice. They have a torx joint, so to use them you need a screwdriver for connection V. In case of use of prostheses AV screwed with I connection systems it is recommended to order separately a screwdriver for V connection in order to properly manage the screwing of superstructures.

Recommended torque for tightening healing abutments and for all laboratory prosthetic screws: 10 Ncm

Recommended torque for tightening prosthetic solutions with direct screw: 30 Ncm

Recommended torque for tightening prosthetic solutions with through screw: 25 Ncm

Recommended torque for tightening superstructures on posts AV: 15 Ncm



Sweden & Martina



Dental Arena



rev. 04-24



Sweden & Martina S.p.A.

Via Veneto, 10
35020 Due Carrare (PD), Italy
Tel. +39.049.9124300
Fax +39.049.9124290
info@sweden-martina.com
www.sweden-martina.com

Sweden & Martina Ltd

Unit 1b
Amberley Court, Whitworth Road
Crawley, West Sussex, RH11 7XL
Toll free 0800 1123575
info.uk@sweden-martina.com

Sweden & Martina Inc.

Distributor for U.S.
4700 S Mill Ave., Ste B-16
PO Box 23748 - Tempe, AZ 85282
Toll free 1-844-8MARTINA (1-844-862-7846)
info.us@sweden-martina.com
www.sweden-martinainc.com

Sweden & Martina Mediterranea S.L.

España - info.es@sweden-martina.com
Sweden & Martina Lda
Portugal - info.pt@sweden-martina.com

The implants, standard prosthetic components and surgical instruments contained in this issue are Medical devices and are manufactured by Sweden & Martina S.p.A. except for:

- OT Equator and related components which are medical devices manufactured by Rhein83 S.r.l.
- ORBIT and related components which are medical devices manufactured by Bionica S.r.l.

They conform to the ISO 9001 and ISO 13485 standards and are certified with the CE in compliance with Regulation (EU) Medical Devices n. 2017/745.



Some products may not be regulatory/released for sale in all markets.

All trademarks herein are the property of Sweden & Martina S.p.A. unless otherwise indicated.

This material is intended for laboratories and clinicians and is not intended for patient distribution.

This material is not to be redistributed, duplicated, or disclosed without the express written consent of Sweden & Martina S.p.A.

For additional product information, including indications, contraindications, warnings, precautions, and potential adverse effects, see Sweden & Martina S.p.A. website.

The contents are updated at the time of publication. Check with the company for any subsequent updates.